

6

5

4

3

2

1

D

D

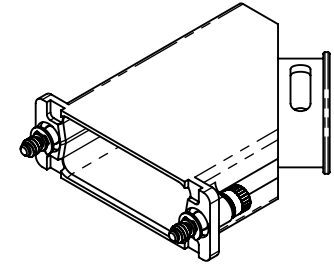
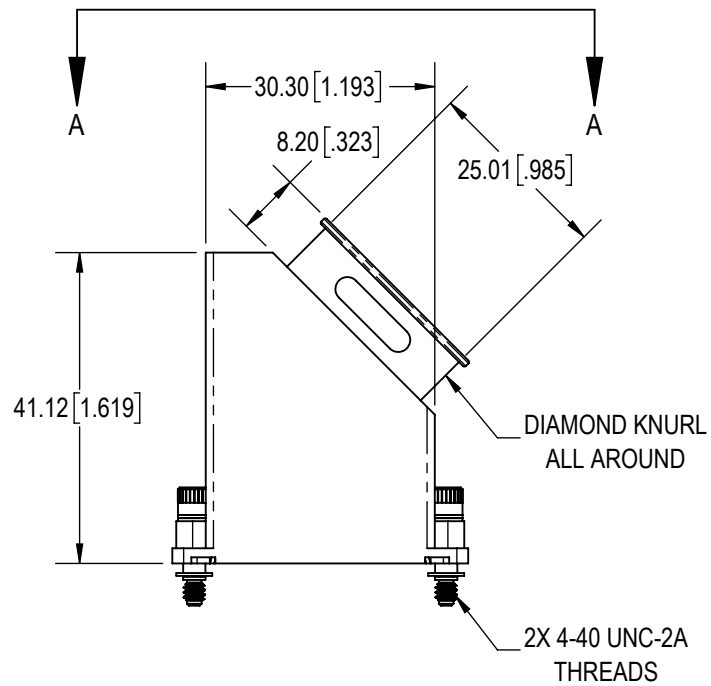

C

C

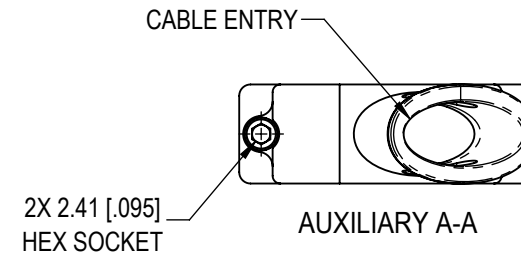

B

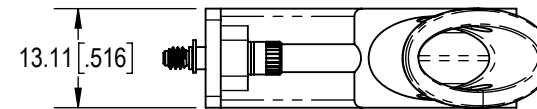
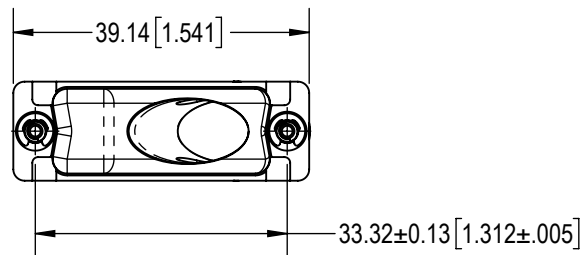

B

**NOTES:**

- MATERIAL AND FINISHES:  
HOOD: ALUMINUM, ELECTROLESS NICKEL PLATE.  
JACKSCREWS: STAINLESS STEEL, PASSIVATED.  
WASHERS: ALUMINUM, ELECTROLESS NICKEL PLATE.  
RETAINING RINGS: STAINLESS STEEL, PASSIVATED.
- DETAILED PRODUCT, MECHANICAL AND ELECTRICAL INFORMATION IS AVAILABLE IN THE LATEST D-SUB ACCESSORIES PRODUCT PUBLICATION AT [CONNECTPOSITRONIC.COM](http://CONNECTPOSITRONIC.COM).
- PRODUCT IS COMPLIANT TO THE CURRENT RoHS DIRECTIVE.

A

A

BY	SS	CHK	AP	3RD ANGLE	<small>POSITRONIC BELIEVES THE DATA ON THE DRAWING TO BE RELIABLE. THE USER EMPLOYS SUCH INFORMATION AT HIS OWN DISCRETION AND RISK. POSITRONIC ASSUMES NO RESPONSIBILITY FOR RESULTS OBTAINED OR DAMAGES INCURRED FROM USE OF SUCH INFORMATION IN WHOLE OR IN PART.</small>	 <b>Positronic®</b> <small>CONNECTPOSITRONIC.COM</small>
APR	AB	RELEASED DATE: 2024-12-04				
TOLERANCES				SCALE	<small>POSITRONIC BELIEVES THE DATA ON THE DRAWING TO BE RELIABLE. THE USER EMPLOYS SUCH INFORMATION AT HIS OWN DISCRETION AND RISK. POSITRONIC ASSUMES NO RESPONSIBILITY FOR RESULTS OBTAINED OR DAMAGES INCURRED FROM USE OF SUCH INFORMATION IN WHOLE OR IN PART.</small>	<small>POSITRONIC BELIEVES THE DATA ON THE DRAWING TO BE RELIABLE. THE USER EMPLOYS SUCH INFORMATION AT HIS OWN DISCRETION AND RISK. POSITRONIC ASSUMES NO RESPONSIBILITY FOR RESULTS OBTAINED OR DAMAGES INCURRED FROM USE OF SUCH INFORMATION IN WHOLE OR IN PART.</small>
<small>±0.03mm [.001 INCHES] FOR MALE CONTACT MATING DIAMETERS  ±0.08mm [.003 INCHES] FOR CONTACT TERMINATION DIAMETERS  ±0.13mm [.005 INCHES] FOR ALL OTHER DIAMETERS  ±0.38mm [.015 INCHES] FOR ALL OTHER DIMENSIONS  +5° FOR ALL ANGLES  DIMENSION ARE IN MILLIMETERS [INCHES]</small>				NTS		
PART NUMBER				SERIES		
D15000XKNE0/AA				D		
TITLE						D15000XKNE0/AA
CREATED ON:			SHEET		REV	
2024-12-03			SHEET 1 OF 1		C	

6

5

4

3

2

1