

6

5

4

3

2

1

D

D

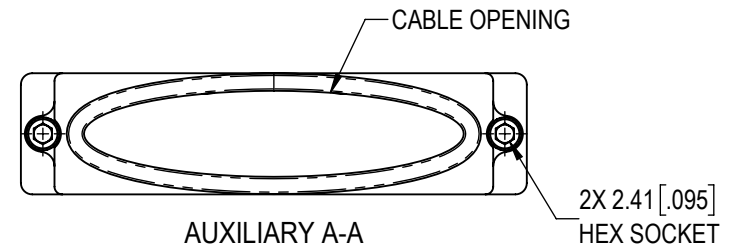
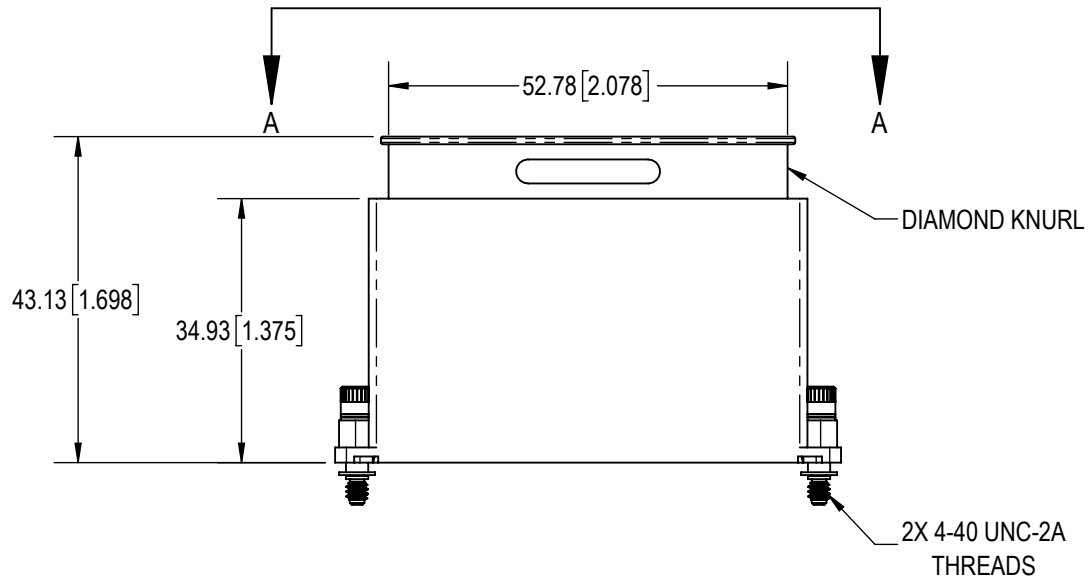
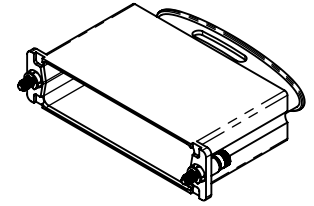

C

C

B

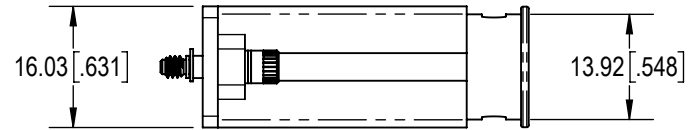
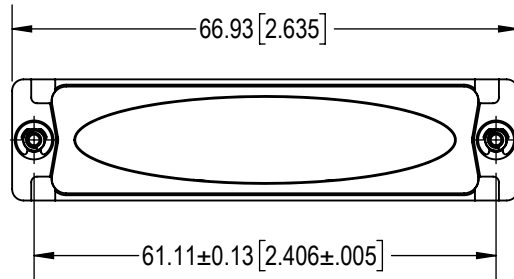

B

**NOTES:**

- MATERIAL AND FINISHES:
HOOD: ALUMINUM, ELECTROLESS NICKEL PLATE.
JACKSCREWS: STAINLESS STEEL, PASSIVATED.
WASHERS: ALUMINUM, ELECTROLESS NICKEL PLATE.
RETAINING RINGS: STAINLESS STEEL, PASSIVATED.
- DETAILED PRODUCT, MECHANICAL AND ELECTRICAL INFORMATION IS AVAILABLE IN THE LATEST D-SUB ACCESSORIES PRODUCT PUBLICATION AT CONNECTPOSITRONIC.COM.
- PRODUCT IS COMPLIANT TO THE CURRENT RoHS DIRECTIVE.

A

A

BY	SS	CHK	AP	3RD ANGLE	POSITRONIC BELIEVES THE DATA ON THE DRAWING TO BE RELIABLE. THE USER EMPLOYS SUCH INFORMATION AT HIS OWN DISCRETION AND RISK. POSITRONIC ASSUMES NO RESPONSIBILITY FOR RESULTS OBTAINED OR DAMAGES INCURRED FROM USE OF SUCH INFORMATION IN WHOLE OR IN PART.	 Positronic® CONNECTPOSITRONIC.COM
APR	AB	RELEASED DATE: 2024-12-04				
TOLERANCES				SCALE	NTS	PART NUMBER
±0.03mm [.001 INCHES] FOR MALE CONTACT MATING DIAMETERS ±0.08mm [.003 INCHES] FOR CONTACT TERMINATION DIAMETERS ±0.13mm [.005 INCHES] FOR ALL OTHER DIAMETERS ±0.38mm [.015 INCHES] FOR ALL OTHER DIMENSIONS ±5° FOR ALL ANGLES DIMENSION ARE IN MILLIMETERS [INCHES]						D50000XPNE0/AA
						SERIES
						D
						TITLE
						D50000XPNE0/AA
						CREATED ON:
						2024-12-03
						SHEET
						SHEET 1 OF 1
						REV
						C

6

5

4

3

2

1