

MATED PLUG & RECEPTACLE CONNECTORS

SCALE: 2/1

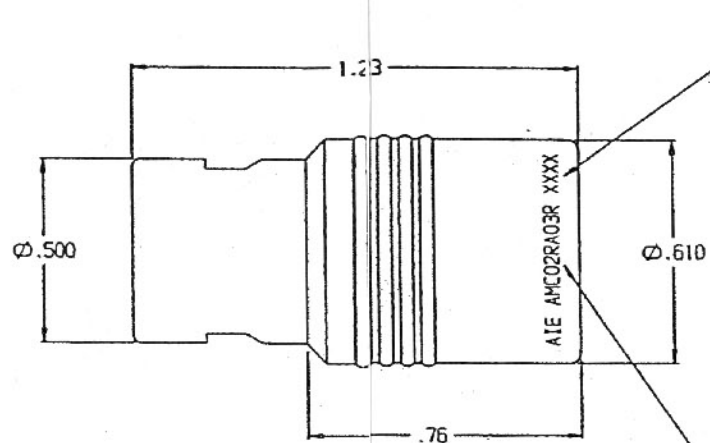

AIE P/N AMCO2RA03R (RED) SHOWN

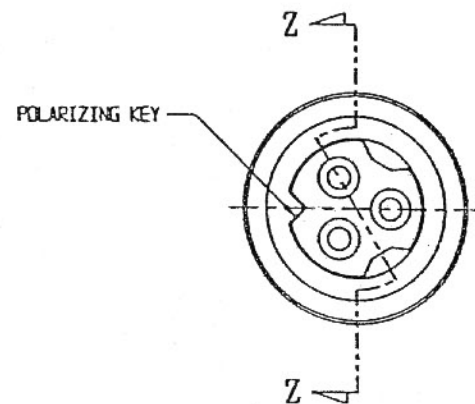
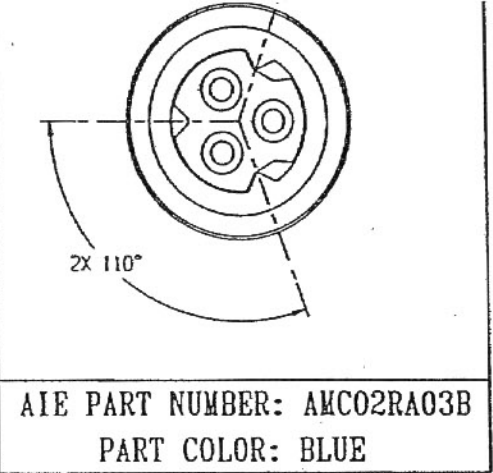
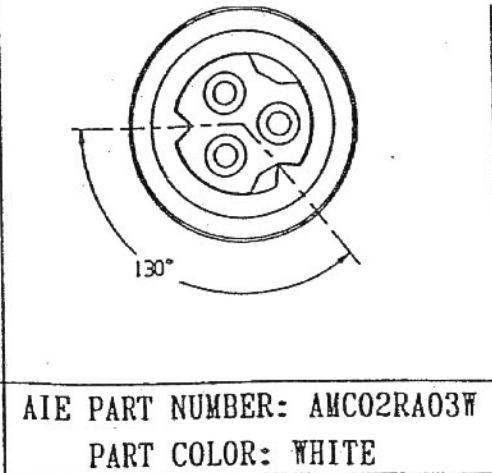
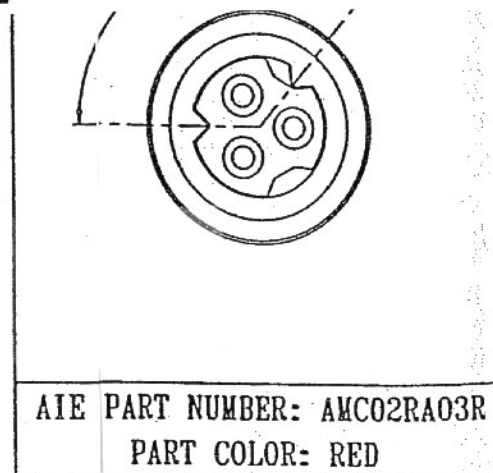
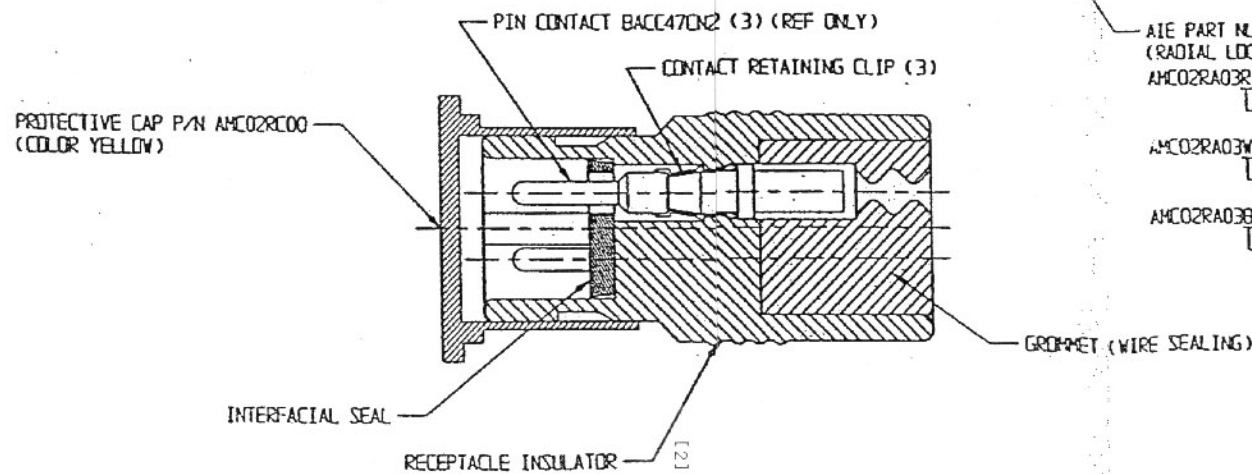
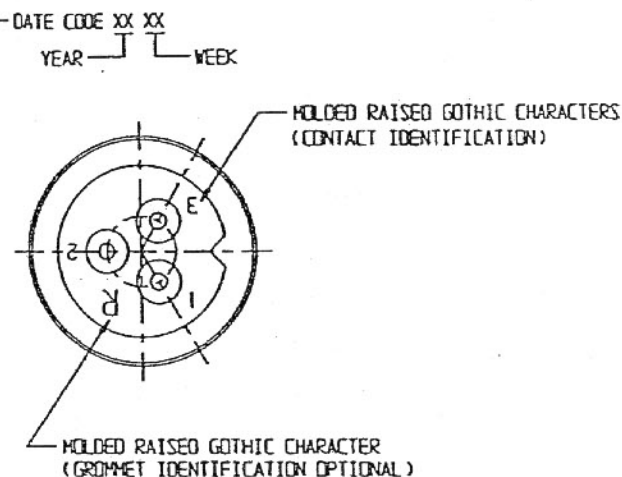

SECTION Z-Z

- AIE PART NUMBER (RADIAL LOCATION OPTIONAL)
- AMCO2RA03R (PART COLOR RED)
- AMCO2RA03W (PART COLOR WHITE)
- AMCO2RA03B (PART COLOR BLUE)

MATERIALS:

RECEPTACLE INSULATOR: THERMOPLASTIC POLYESTER BASE ELASTOMER (TPE)  
 COLORS RED, WHITE & BLUE  
 MANUFACTURER: RTP COMPANY  
 580 EAST FRONT STREET  
 WINONA, MN 55987  
 MANUFACTURER PART NUMBER: 1599X71817

CONTACT RETAINING CLIP: BERYLLIUM COPPER, HEAT TREATED  
 GROMMET & INTERFACIAL SEAL: SILICONE RUBBER, COLOR RED  
 PROTECTIVE CAP: POLYETHYLENE, COLOR YELLOW

NOTES:

1. MARKING: EACH CONNECTOR WILL BE PERMANENTLY AND LEGIBLY MARKED WITH THE MANUFACTURER'S NAME OR TRADE MARK, MANUFACTURER'S PART NUMBER & DATE CODE, RADIAL LOCATION OPTIONAL.
2. ACCEPTS SIZE 16 PIN CONTACT, BACC470N2 PER BOEING STANDARD BACC470N, (CONTACT NOT SUPPLIED WITH CONNECTOR).
3. PERFORMANCE CHARACTERISTICS, PACKAGING AND QUALITY ASSURANCE REQUIREMENTS PER ARIZONA INTEGRATED ELECTRONICS PRODUCT SPECIFICATION PS-AMCO2PROO.
4. WEIGHT OF THE RECEPTACLE ASSEMBLY WITH PROTECTIVE CAP: .22 OUNCES MAXIMUM

CUSTOMER DRAWING

VIKING		VIKING ELECTRONICS, INC. 9230 INDEPENDENCE AVENUE DULUTH, CALIFORNIA 91311	
DATE	9-17-91	DATE	
DRW	CP	DATE	
ASSEMBLY, RCPT AIRBORNE		MATERIALS CONTROL	